

# Installation and Start-Up Instructions

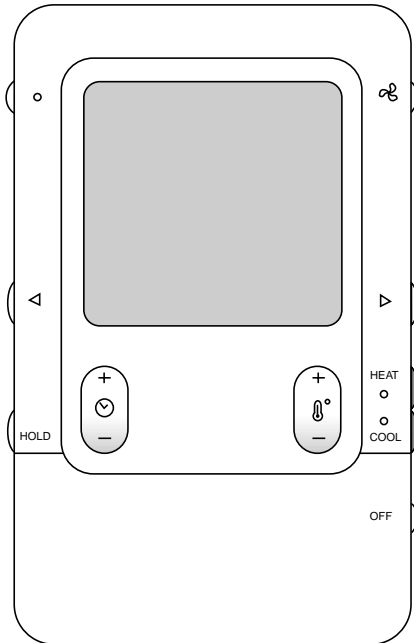

**Infinity Control™**  
**SYSTXCCUID01**

A03149

**NOTE:** Read the entire instruction manual before starting the installation.

This symbol → indicates a change since the last issue.

## TABLE OF CONTENTS

SAFETY CONSIDERATIONS .....	1
INTRODUCTION .....	1
INSTALLATION AND START-UP OVERVIEW .....	1
INSTALLATION .....	2
INITIAL POWER-UP.....	5
QUICK START.....	6
INSTALL / SERVICE MENUS.....	7
OPERATIONAL INFORMATION.....	11
TROUBLESHOOTING .....	12

## SAFETY CONSIDERATIONS

Read and follow manufacturer instructions carefully. Follow all local electrical codes during installation. All wiring must conform to local and national electrical codes. Improper wiring or installation may damage Infinity Control System. Recognize safety information. This is the safety-alert symbol . When you see this symbol on the equipment and in the instruction manual, be alert to the potential for personal injury. Understand the signal words **DANGER**, **WARNING**, and **CAUTION**.

These words are used with the safety-alert symbol. **DANGER** identifies the most serious hazards, which **will** result in severe personal injury or death. **WARNING** signifies a hazard, which **could** result in personal injury or death. **CAUTION** is used to identify unsafe practices, which **would** result in minor personal injury or product and property damage. **NOTE** is used to highlight suggestions which will result in enhanced installation, reliability, or operation.

## INTRODUCTION

The Infinity System consists of intelligent communicating components (User Interface, variable speed furnace or fan coil, AC or HP), which continually communicate with each other via a four-wire connection called the ABCD bus. Conventional 24-volt signals on dedicated wires are not needed. Commands, operating conditions, and other data are passed continually between the components over the ABCD bus. The result is a new level of comfort, versatility, and simplicity.

An Infinity System consists of a Infinity Control™ (thermostat plus much more) and an Infinity furnace or fan coil. All Infinity furnaces or fan coils are variable-speed and multi stage for maximum flexibility, efficiency, and comfort. They support controlled ventilation, humidification, dehumidification, and air quality control. Either an Infinity dual capacity (communicating), or a standard 24 vac controlled outdoor unit may be used.

When using conventional outdoor units, the Infinity furnace or fan coil provides the 24 volt signals needed to control them. Also, the Infinity Network Interface Module (NIM) allows connection of a conventional HRV or ERV without the need for a separate wall control.

All system components are controlled through the wall mounted Infinity Control™, which replaces the conventional thermostat and provides the homeowner with a single wall control for all the features of the system.

## INSTALLATION AND START-UP OVERVIEW

This instruction covers installation of the Infinity Control™ **only**. Physical installation instructions for the indoor, outdoor equipment and accessories are provided with each unit.

Setup, commissioning, operation, and troubleshooting of the Infinity System is covered **only** in this installation instruction. It is your guide to connecting the system components and commissioning the system once all the physical components are installed. Special screen prompts and start-up capabilities are provided in the Infinity System to simplify and lead you through the initial commissioning of the system. So:

- Install the Infinity Control™ according to this instruction.
- Install the indoor unit, outdoor unit, and accessories according to their instructions.
- Wire the complete system according to this instruction.
- Setup, commission, and operate the system according to this instruction to assure yourself a smooth and trouble free start-up.

## INSTALLATION

### STEP 1 — CHECK EQUIPMENT AND JOB SITE

**INSPECT EQUIPMENT** — File claim with shipping company, prior to installation, if shipment is damaged or incomplete.

### STEP 2 — INFINITY CONTROL™ LOCATION AND WIRING CONSIDERATIONS

#### ⚠ WARNING

##### ELECTRICAL SHOCK HAZARD

Failure to follow this warning could result in personal injury or possible equipment damage.

Disconnect Power before routing control wiring.

All wiring must comply with national, local, and state codes.

**INFINITY CONTROL™ LOCATION**— The Infinity Control™ is the command center for the Infinity System. It should be located where it is easily accessible and visible to the adult homeowner or end user.

For accurate temperature measurement, the following guidelines should be followed:

The Infinity Control™ should be mounted:

- Approximately 5 feet (1.5 meters) from the floor.
- Close to or in a frequently used room, preferably on an inside partitioning wall.
- On a section of wall without pipes or duct work.

The Infinity Control™ should NOT be mounted:

- Close to a window, on an outside wall, or next to a door leading to the outside.
- Exposed to direct light or heat from a lamp, sun, fireplace, or other temperature-radiating objects which could cause a false reading.
- Close to or in direct airflow from supply registers.
- In areas with poor air circulation, such as behind a door or in an alcove.

**REMOTE SENSOR OPTION** — A remote room sensor can be used with the Infinity Control™ to take the place of the internal temperature sensor. This allows the control to be mounted in areas with less than optimal airflow (such as near an exterior door, window or in a closet). The remote sensor is wired to the terminal block connectors labeled S1 and S2. The Infinity Control™ will automatically detect the remote sensor and ignore its internal sensor. It is also important to note the humidity sensor cannot be remotely located, so do not locate the Infinity Control™ in an area where humidity sensing may not be accurate.

**NOTE:** S1 & S2 connection on UI back-plate is now used for the Remote Room Sensor, **NOT** for OAT Sensor hookup (S1 & S2 was previously used for OAT).

**WIRING CONSIDERATIONS** — Ordinary thermostat wire is recommended. Use 22 AWG or larger for normal wiring applications. Continuous wire lengths over 100 ft. should use 20 AWG or larger.

**NOTE:** ABCD bus wiring only requires a four-wire connection; however, it is good practice to run thermostat cable having more than four wires in the event of a damaged or broken wire during the installation.

Each device in the Infinity System has a four-pin connector labeled ABCD. It is recommended that the following color code be used when wiring each device:

- A — Green = Data A
- B — Yellow = Data B
- C — White = 24VAC (Com)
- D — Red = 24VAC (Hot)

It is not mandatory that the above color code be used, but each ABCD connector in the system **MUST** be wired consistently.

**MOUNTING INFINITY CONTROL™** — There are two options for mounting the Infinity Control™ to the wall. First, familiarize yourself with all plastic assembly pieces shown in Figs. 2 through 9. The User Interface will snap together with either the Recess Mount or the Surface Mount backplate.

**RECESS MOUNT** — This provides the thinnest mounting configuration (See Fig. 3). The backplate containing the recessed terminal block can be mounted directly to the wall by cutting a hole 1 1/2" wide by 2 1/8" high. Mark location and cut hole in wall.

**NOTE:** Always ensure the Infinity Control™ location is acceptable before cutting any holes in wall.

**SURFACE MOUNT** — This provides surface mounting configuration, which allows use of a small hole in the wall. A surface mount backplate is supplied (See Fig. 4). Attach backplate as shown in figure 7, and the assembly will mount directly to the wall requiring only a small hole in the wall allowing a four wire connection to pass through.

**NOTE:** Once Infinity Control™ is secured to wall with the backplate assembly (snapped together), care must be taken not to bend or break the interlocking tabs when removing. Gently remove Infinity Control by rocking up/down until interlocking tabs release.

**DECORATIVE BACKPLATE** — Supplied, is a thin, decorative backplate (see Fig. 5), to hide any marks/screw holes left from the previous thermostat. This decorative backplate (or beauty ring) can be used in either the recess or surface mount installation by snapping it onto the back of the recessed mount backplate or surface mount backplate before securing to the wall. See Fig. 8 and 9 for a larger decorative backplate (5.75" wide X 6" tall), which can be ordered separately.

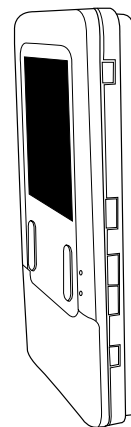

A03185

Fig. 2—Infinity Control™

### STEP 3 — INSTALLING INFINITY CONTROL™

#### ⚠ WARNING

##### ELECTRICAL SHOCK HAZARD

Failure to follow this warning could result in personal injury or death.

Before installing Infinity Control™, turn off all power to equipment. There may be more than one power source to disconnect.

1. Turn off all power to equipment.
2. If an existing thermostat is being replaced:
  - a. Remove existing thermostat from wall.
  - b. Disconnect wires from existing thermostat.

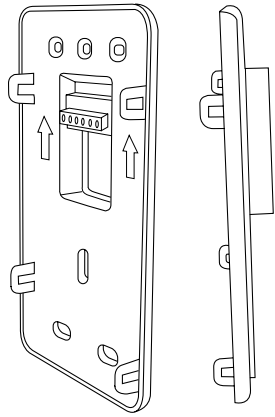

A03186

**Fig. 3—Recessed Mount Backplate**

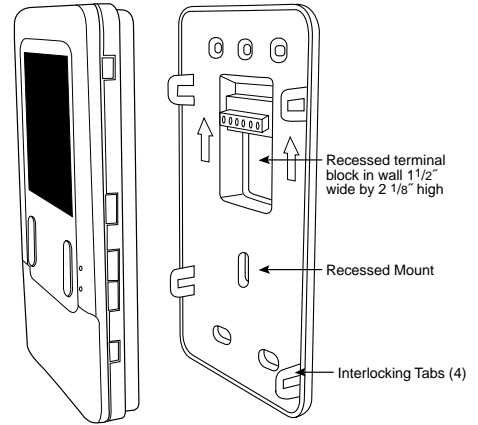

A03190

**Fig. 6—Recessed Mount Assembly**

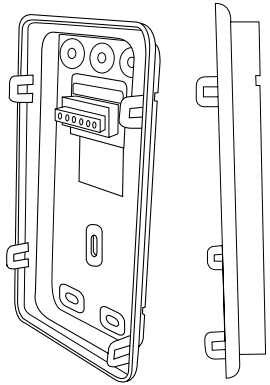

A03187

**Fig. 4—Surface Mount Backplate**

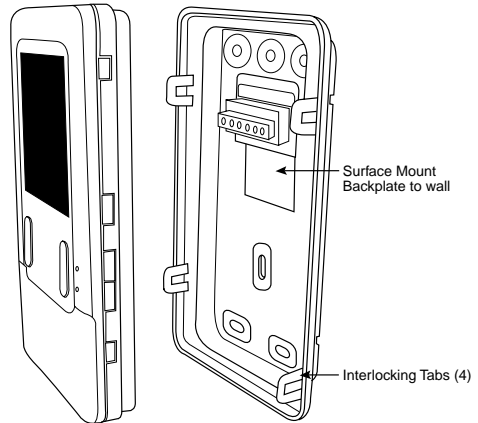

A03191

**Fig. 7—Surface Mount Assembly**

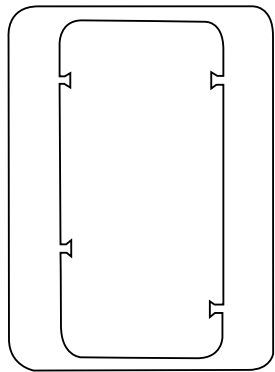

A04017

**Fig. 5—Thin Decorative Backplate**

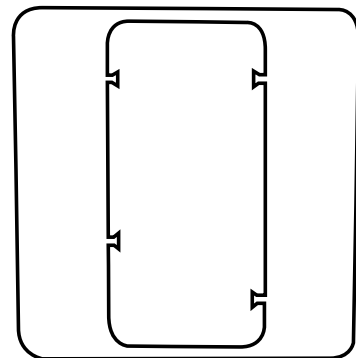

A03188

**Fig. 8—Large Decorative Backplate**

c. Discard or recycle old thermostat.

**NOTE:** Mercury is a hazardous waste and **MUST** be disposed of properly.

3. Select Infinity Control™ mounting plastic (recess mount or surface mount and decorative backplate if desired).
4. Route wires through large hole in mounting plastic. Level rear plastic against wall (for aesthetic value only - Infinity Control™ need not be level to operate properly) and mark wall through two mounting holes.
5. Drill two 3/16 inch mounting holes in wall where marked.
6. Secure mounting plastic to wall using two screws and anchors provided.
7. Adjust length and routing of each wire to reach each wire entry on the connector backplate. Strip ¼ inch of insulation from each wire.

8. Match and connect thermostat wires to proper terminals on User Interface backplate. See wiring diagram figures 12, 13 and 14.

- A — Green = Data A
- B — Yellow = Data B
- C — White = 24VAC (Com)
- D — Red = 24VAC (Hot)

**NOTE:** It is not mandatory that the above color code be used, but each ABCD connection in the system **MUST** be wired consistently. A separate ABCD Connector comes inside packaging and should be used when connecting to the furnace (or fan coil). (See Fig. 10)

**NOTE:** Insert connector properly into circuit board.

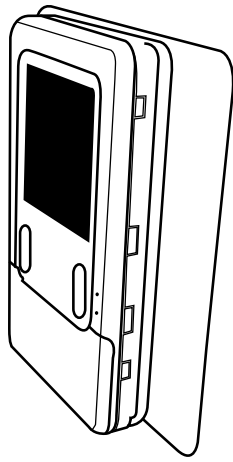

**Fig. 9—Decorative Backplate Assembly**

A03192

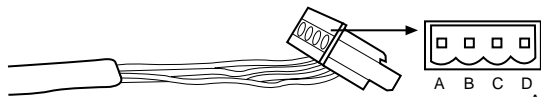

**Fig. 10—4-Wire ABCD Connector**

A03193

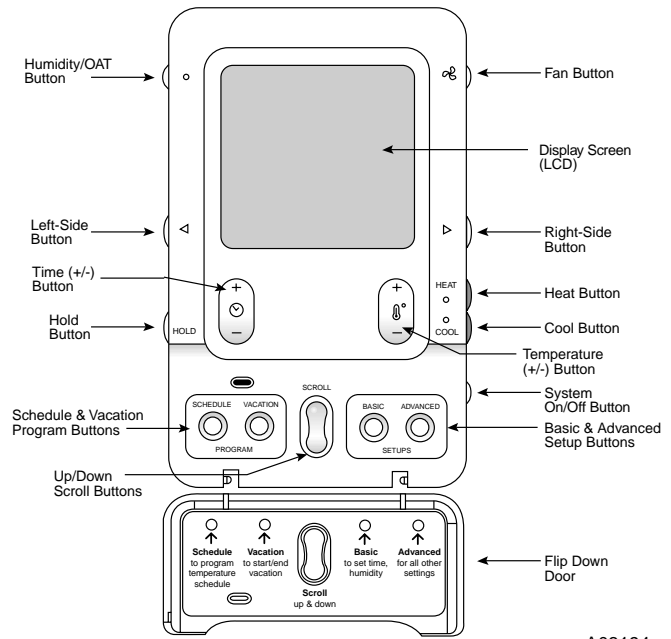

**Fig. 11—Functional Overview**

A03194

**⚠ CAUTION**

**ELECTRICAL OPERATION HAZARD**  
 Failure to follow this caution will result in equipment damage or improper operation.  
 Improper wiring of the ABCD connector will cause the Infinity Control™ to operate improperly. Check to make sure all wiring is correct before proceeding with installation or turning on power.

9. Push any excess wire into the wall. Seal hole in wall to prevent any air leaks. Leaks can affect operation.
10. Attach Infinity Control™ to the mounting plastic by lining up the plastic guides on the back of the control with the opening on the mounting plastic and push on.
11. Perform installation of all other system equipment (i.e. humidifier, ventilator, UV lights, etc.)
12. Turn on power to equipment.

**EQUIPMENT WIRING DIAGRAMS:**

See wiring diagram Figs. 12, 13 and 14.

**NOTE:** For other applications not listed, refer to the Network Interface Module (NIM) Installation Instructions.

See wiring diagram figure 12 for a Typical Four-Wire Connection Diagram, which includes an Infinity indoor communicating furnace or FE fan coil with a 2-speed Puron® communicating outdoor unit. No additional OAT (outdoor air temperature) sensor is required because the Infinity Control will use the temperature sensor inside the 2-speed unit.

See wiring diagram figure 13 for a Typical Connection Diagram, which includes an Infinity indoor communicating furnace or FE fan coil, with a 1-speed air conditioning unit (non-communicating outdoor). An Outdoor Air Temperature sensor may be installed (not required) at the indoor furnace or fan coil OAT terminals. When OAT is applied, the Infinity System will provide full system features and benefits.

See wiring diagram Fig. 14 for a Typical Connection Diagram for FE fan coil with a 1-speed heat pump (using non-communicating outdoor unit). When OAT is applied, the Infinity System will provide full system features and benefits.

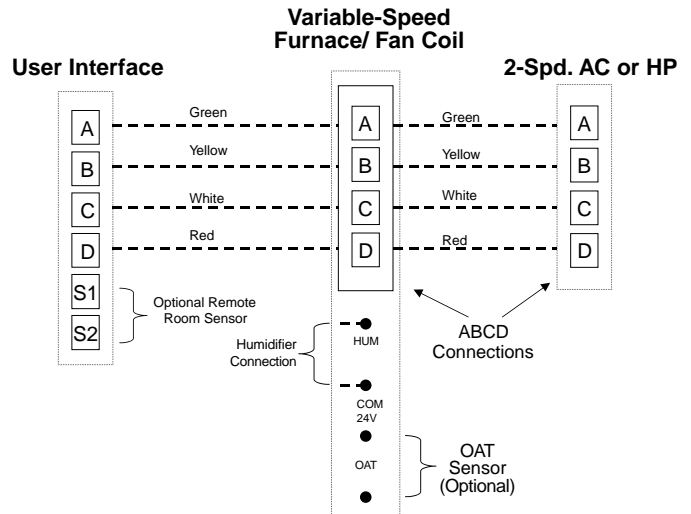

**Fig. 12—Universal Four-Wire Connection Diagram**

A03146

**HUMIDIFIER CONNECTION** — A 24vac bypass or fan powered humidifier may be installed.

**NOTE:** Do Not Use a traditional humidistat to control humidifier operation. If a humidifier is installed, let the Infinity System control humidifier operation.

**Bypass Humidifiers** — A bypass humidifier should be wired directly to the furnace or fan coil HUM and 24vac COM terminals. The Infinity Control will automatically energize the HUM output during a call for humidification.

**Fan Powered Humidifiers** — Most fan powered humidifiers produce internal 24vac in order to energize upon a switch or contact closure. For this application, a 24vac N.O. Isolation Relay (DPST) **MUST be used** to prevent mixing the internal humidifier power with the indoor equipment transformer. Applying 24vac isolation relay coil to furnace or fan coil HUM and COM terminals will allow the Infinity Control to automatically energize the HUM output during a call for humidification. The N.O. relay contacts will be used to energize the humidifier. See fan powered humidifier installation instructions for more details.

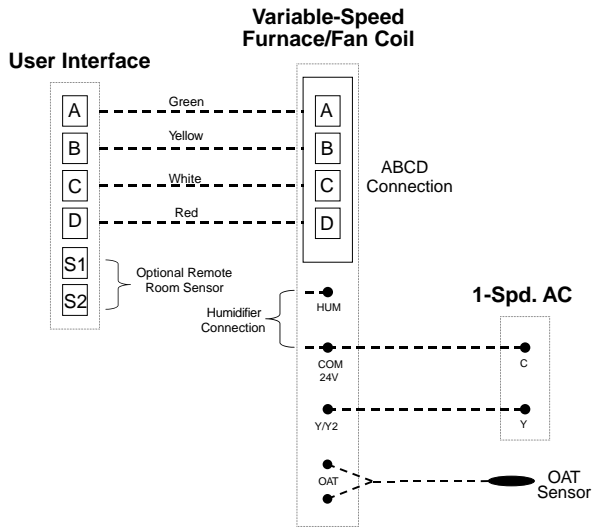

**Fig. 13—Connection Diagram for Furnace or FE Fan Coil w/1-Spd. AC**  
A03147

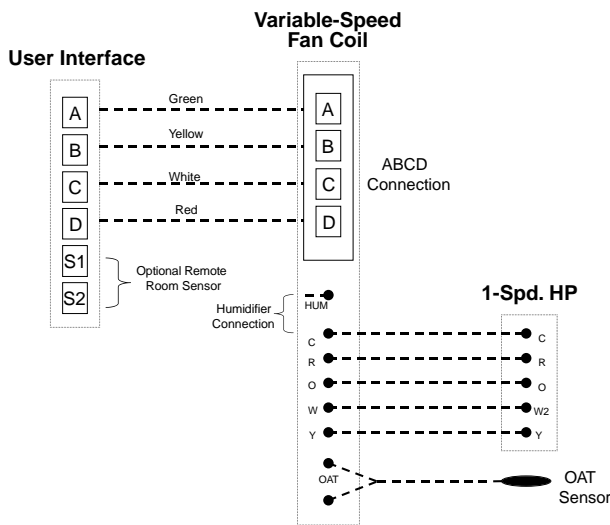

**Fig. 14—Connection Diagram for FE Fan Coil w/1-Spd. HP**  
A03148

**⚠ WARNING**

**FIRE OR EQUIPMENT HAZARD**  
Failure to follow this warning could result in equipment damage or fire.  
Do not apply 24vac fan powered humidifier (with internal power supply) direct to indoor unit HUM and COM terminals.

**INITIAL POWER-UP**

**NOTE:** Refer to Functional Overview (Fig. 11) to become familiar with key function buttons such as "System On/Off", "Fan", "Left-Side" and "Right-Side" buttons, etc. These function buttons will be used frequently during setup.

**SECTION 1 — POWER UP SEQUENCE**

This section addresses initial power up (or commissioning) of a new Infinity Control™. The User Interface will communicate and identify all Infinity components in the system. The following is a

typical example for a communicating Variable-Speed Furnace / Fan Coil with a 2-sp. Air Conditioner / Heat Pump (including Dual Fuel).

The User Interface display will light up and indicate that it is now "ESTABLISHING COMMUNICATIONS WITH EQUIPMENT PLEASE WAIT". The User Interface will automatically continue by "SEARCHING FOR INDOOR EQUIPMENT", followed by "SEARCHING FOR OUTDOOR EQUIPMENT" (See Figure 15). Once the indoor and outdoor equipment has been found, the Installer will be asked to select Accessories. Proceed to Section 4. Selecting Accessories.

**NOTE:** If the variable-speed indoor equipment (furnace or fan coil) cannot be found, the User Interface will display "CANNOT COMMUNICATE WITH INDOOR UNIT". This **MUST** be corrected before the initial power up sequence can continue. If indoor unit is found, but the outdoor unit is not found, "OUTDOOR UNIT NOT IDENTIFIED" will appear. Proceed to the next section for Outdoor Unit Identification.



**Fig. 15 — Power Up Sequence**

**SECTION 2 — SELECTING OUTDOOR UNIT**

If there is no communicating outdoor unit, the screen, shown in Fig. 16, will appear. Press either Time or Temp +/- buttons to select AC (air conditioner), HP (heat pump), or None (no unit installed). Press the right-side button to continue to the next screen.

If you have selected either AC or HP as the outdoor unit type, the following middle screen will appear (See figure 16). Press either Time or Temp +/- buttons to select appropriate Btu size of outdoor unit, then press right side button to continue. If a NIM (Network Interface Module) is applied for non-communicating two-speed outdoor equipment, select 1 or 2 speed compressor operation, and press right-side button to continue.

**NOTE:** Range of Btu selection is limited by the model number of the indoor unit installed. The Infinity Control™ will not allow an outdoor unit size that is not supported by the installed indoor unit.

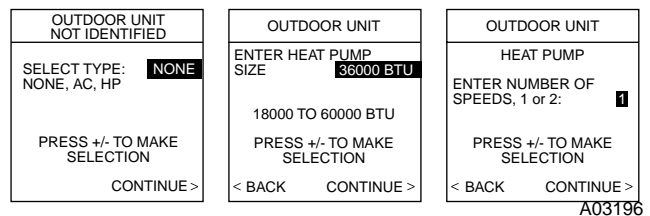

**Fig. 16—Selecting Outdoor Unit**

**NOTE:** On new system installations, the model and serial number will be recognized and displayed. On any indoor/outdoor board replacements, the equipment will be recognized but the exact model/serial number will not be displayed.

**SECTION 3 — SELECTING ELECTRIC HEATER**

If the indoor unit is a fan coil and the electric heater is not self-identifying, "ELECTRIC HEATER NOT IDENTIFIED" will appear (See Figure 17). Press either Time or Temp +/- buttons to select appropriate size of electric heater installed, then press the right-side button to continue.

**NOTE:** Range of electric heaters available is limited by the model of the fan coil installed. The Infinity Control™ will not allow an electric heater size that is not supported by the installed fan coil.

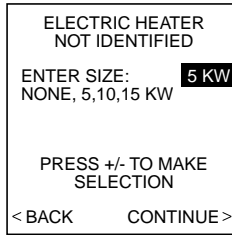

A03197

**Fig. 17—Selecting Electric Heater**

**SECTION 4 — SELECTING ACCESSORIES**

Once the indoor and outdoor equipment have been found or entered, the following screens will appear allowing the Installer to select the AIR FILTER TYPE; HUMIDIFIER INSTALLED; and UV LIGHTS INSTALLED” (See Fig. 18). Use either Time or Temp +/- buttons to make the appropriate selections in the highlighted area on the display screen. Press right-side button to continue (or advance) to the next screen.

**AIR FILTER TYPE**— This accessory screen will appear first. The installer will need to enter the type of filter (MEDIA, EAC, or both). See Table 1 and make a selection using Time or Temp +/- button, then press right-side button to continue.

**Table 1 — Filter Selection**

INSTALLED FILTER	MENU SELECTION
1 Inch to 4 inch media	MEDIA
High voltage EAC	EAC
High voltage EAC + 1 to 4 inch media	MEDIA + EAC

**HUMIDIFIER TYPE** — This will appear after the Air Filter Type screen. Select whether a humidifier is installed on the system, YES or NO, then press the right-side button to continue.

**UV LIGHTS INSTALLED**— This screen will appear to select whether UV lights are installed on the system, select YES or NO, then press the right side button to continue.

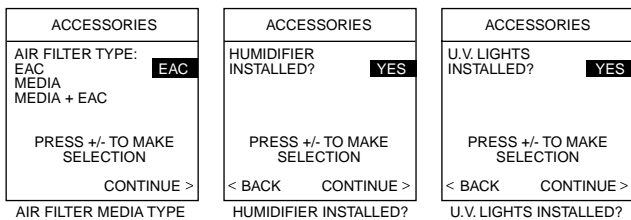

A03198

**Fig. 18—Accessories — UV Lights**

**SECTION 5 — EQUIPMENT SUMMARY**

The “EQUIPMENT SUMMARY” screen will appear after Accessories have been selected. This screen will give a summary of all equipment automatically found or manually selected. If a wrong selection was made, press left-side button (BACK selection) to go back to that particular screen and make changes. When everything is OK, press right-side button again to continue. (See figure 19)

The “SETUP COMPLETE! SAVE ALL SELECTIONS?” screen will appear after Equipment Summary. To Save All Selections press (YES) right-side button. Pressing the left-side button (NO selection) will return to the Equipment Summary screen where you can back up to any of the equipment selection

screens and perform changes. After selecting YES, the initial power up sequence of the new Infinity Control™ is complete. The User Interface screen will now display normal operating mode. Also, after selecting YES, if the filter type is **not** an EAC, the indoor unit will operate the blower for one minute to do a system static pressure check.

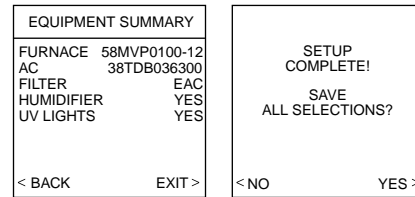

A03199

**Fig. 19—Equipment Summary**

**QUICK START**

For first time installers, Quick Start will allow you to start up the Infinity System before you have the chance to learn all the details of system operation. However, for the best possible comfort and operation we recommend that you refer to the Infinity Control™ Homeowner’s Guide.

**SET DAY, TIME & DESIRED HUMIDITY**

1. Flip down the door at the base of the Infinity Control™ and press the **BASIC** button.
2. Adjust the highlighted **HOUR** setting using the **TIME (+/-)** button.
3. Press **SCROLL** button (down) to highlight **MINUTE**.
4. Adjust the **MINUTE** setting using the **TIME (+/-)** button.
5. Press **SCROLL** button (down) to highlight **DAY**.
6. Adjust the current **DAY** setting using the **TIME (+/-)** button.
7. Press **SCROLL** button (down) to highlight **HUMIDITY**.
8. Press the red **HEAT** button to select heating humidity.
9. Adjust desired heating humidity level using either (+/-) button.
10. Press the blue **COOL** button to select cooling humidity.
11. Adjust the desired cooling humidity level using either(+/-)button.
12. To exit press **BASIC** button or close door.

**OVERRIDE HEATING SCHEDULE**

1. Press the red **HEAT** button. Heating mode is confirmed when the red LED next to the red **HEAT** button is lit.
2. Use the **TEMP (+/-)** button to select your desired heating temperature.
3. The default time for temporarily overriding the temperature schedule is 2:00 HRS as indicated by the text on the lower left.

**NOTE:** Override time will not appear if programming has been turned off.

4. You can change the temporarily override time in 15-minute increments by pressing the **TIME (+/-)** button until the desired override time is selected, or press the **HOLD** button anytime to override the schedule indefinitely.

**OVERRIDE COOLING SCHEDULE**

1. Press the blue **COOL** button. Cooling mode is confirmed when the blue LED next to the **COOL** button is lit.
2. Use the **TEMP (+/-)** button to select your desired cooling temperature.
3. The default time for temporarily overriding the temperature schedule is 2:00 HRS as indicated by the text on the lower left.

**NOTE:** Override time will not appear if programming has been turned off.

4. You can change the temporary override time in 15-minute increments by pressing the **TIME (+/-)** button until the desired override time is selected, or press the **HOLD** button anytime to override the schedule indefinitely.

#### QUICK PROGRAM SCHEDULE FOR ALL DAYS

This section will give you a quick program schedule for **All Days** of the week. For more information on how to create customized schedules for every day, the entire week, or weekend, refer to the Homeowner's Guide.

1. Flip down the door at the bottom of the control.
2. Press the **SCHEDULE** button, which allows you to create one schedule for the entire home.
3. Press either the **LEFT** or **RIGHT** side button repeatedly (if necessary) until "**ALLDAYS**" is displayed. The **WAKE** time period will be highlighted.
4. Using the **TIME (+/-)** button, set the start time for this time period.
5. Press the red **HEAT** button. Heating temperature will begin flashing.
6. Set the heating temperature using the **TEMP (+/-)** button.
7. Press the blue **COOL** button. Cooling temperature will begin flashing.
8. Set the cooling temperature using the **TEMP (+/-)** button.
9. Set the remaining periods by using the **SCROLL** button to select "**DAY**," "**EVENING**," and "**SLEEP**".
10. Exit the scheduling mode by either closing the door or pressing the **SCHEDULE** button.
11. If changes are made, you will be asked to "**SAVE CHANGES YES/NO**"

#### INSTALL / SERVICE MENUS

The "**INSTALL / SERVICE**" menus contain a set of vital information. This information enables the Installer or Service person to view a summary of what has been installed, etc.

To enter **INSTALL / SERVICE** menus, press and hold the **ADVANCED** button for at least ten seconds. The following menu will appear (See figure 20):

**NOTE:** The **INSTALL / SERVICE** menu will automatically exit after 60 minutes of no push button activity.

**EQUIPMENT SUMMARY:** Shows all equipment recognized by and attached to the system.

**INSTALL:** Used when adding, changing out, or uninstalling equipment.

**SETUP:** Used to view or modify equipment settings.

**CHECKOUT:** Allows testing of equipment operation

**SERVICE:** Used to view operation and fault history of equipment and enter dealer name/phone number for display.

INSTALL/SERVICE	
EQUIPMENT SUMMARY	
INSTALL	
SETUP	
CHECKOUT	
SERVICE	
SOFTWARE VERSION 1	
< EXIT	SELECT >

A03200

**Fig. 20 — INSTALL / SERVICE MENUS**

#### EQUIPMENT SUMMARY MENU

An example screen is shown in Fig. 21:

EQUIPMENT SUMMARY	
FURNACE	58MVP0100-12
AC	38TDB036300
FILTER	EAC
HUMIDIFIER	YES
UV LIGHTS	YES
< BACK	

A03201

**Fig. 21 — EQUIPMENT SUMMARY**

This screen shows indoor unit type and model number, outdoor unit type (and model number if a 2-speed unit), filter type, any accessories that are installed.

#### INSTALL MENU

This menu item will perform start-up process in order to learn all equipment in system. Press right side button to initiate the process.

INSTALL	
TO ADD, UNINSTALL OR RE-INSTALL EQUIPMENT, PRESS RIGHT SIDE BUTTON	
< BACK	INSTALL >

A03202

**Fig. 22 — INSTALL**

## SETUP MENU

This menu has several layers, allowing modification of equipment settings. No settings will need to be made at equipment (i.e. dip switches on a furnace). All configuration settings are made effective from this menu. Fig. 23 shows all the information that can be found in the **SETUP** menu.

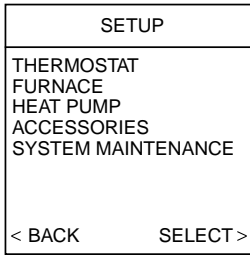

A03203

Fig. 23 — SETUP MENU

### SETUP = THERMOSTAT:

#### AUTO MODE SETUP:

- Enable/Disable Auto Changeover mode (default=Enable).
- Auto Changeover Time may be adjusted 5 to 120 minutes, (default = 30 minutes).

When Auto mode is enabled (factory default) a change from heat to cool (or vice versa) will not occur until an opposite mode demand has existed for 30 minutes. If the set point is changed, the 30 minute timer is deleted.

#### HEAT/COOL DEADBAND:

- 0 to 6 degrees, (default = 2°).

A minimum difference of 2° is enforced between heating and cooling desired temperatures. This will allow one setting to “push” the other to maintain this difference.

**OFFSETS:** This option allows calibration (or deliberate miscalibration) of the temperature and humidity sensors. These offsets are added to the actual temperature/humidity values (defaults = 0).

- Room Temp Offset: -5 to +5 degrees.
- Outside Temp Offset: -5 to +5 degrees.
- Humidity Offset: -10 to +10 percent.

#### CYCLES PER HOUR:

- Maximum cycles per hour = 4 (default) or 6.
- Anticipator = 1 to 9 (default=3).

#### PROGRAMMING:

- On or Off (default=On)
- Periods Per Day = 2 or 4 (default=4)
- Programmable Fan On/Off (default=Off)

#### SMART RECOVERY:

- On or Off, (default=On)

Applies to programmable operation **only**. Will start recovery 90 minutes prior to schedule change in both heating and cooling.

#### ENGLISH/METRIC DISPLAY:

- °F or °C, (default = °F)

#### RESET FACTORY DEFAULTS:

##### Program Schedule:

- Yes/No to reset back to Energy Star defaults.

##### User Settings:

- Yes/No to reset the user settings in the Advanced Setup.

##### Install Settings:

- Yes/No to reset install settings in Install/Service menus.

### SETUP = FURNACE:

Upon a first time start-up of the Infinity Control™, the furnace dip switch settings will be copied to the furnace setup menu. Any changes can then be made from the Infinity Control™.

#### AIRFLOW:

- COMFORT (default)
- EFFICIENCY

Selects the airflow of the furnace when heating. **EFFICIENCY** is the airflow used to meet specified ratings, **COMFORT** is a decreased airflow used to increase the output air temperature and provide increased comfort.

#### AC AIRFLOW:

- COMFORT (default)
- EFFICIENCY
- MAXIMUM

Selects the airflow of the furnace when cooling. **COMFORT** is a decreased airflow used to improve humidity control. **EFFICIENCY** is the airflow used to meet specified ratings. **MAXIMUM** is a fixed airflow speed of 400 CFM/ton based on the outdoor unit size.

#### DEHUM AIRFLOW:

- NORMAL (default)
- HIGH

**NORMAL** airflow adjustment is used during dehumidifying. If duct sweating is an issue, selecting **HIGH** will increase the dehumidifying airflow speed and reduce the sweating.

#### LOW HEAT RISE:

- ON
- OFF (default)

Set this to ON if the system contains a bypass humidifier. The ON setting will increase the furnace low heat airflow.

#### STAGING:

- SYSTEM (default)
- FURNACE
- LOW
- HIGH

Controls the staging of the furnace. **SYSTEM** setting will allow the Infinity Control™ to determine furnace staging. **FURNACE** will allow the Furnace algorithm to control staging. **LOW** will only run the low stage of furnace heat. **HIGH** will only run the high stage of furnace heat.

#### OFF DELAY:

- 90 seconds (default)
- 120 seconds
- 150 seconds
- 180 seconds

Amount of time the blower will continue to run after heating has shut off.

#### LOCKOUT TEMP:

- NONE (default)
- +5 to 55 deg F

Appears on **dual fuel** systems only (furnace with heat pump). Outside temperature above which the furnace will NOT run.

## **SETUP = FAN COIL:**

### HP/AC AIRFLOW:

- COMFORT (default)
- EFFICIENCY
- MAXIMUM

Selects the airflow of the fan coil when heating or cooling with a heat pump (or cooling with an AC unit). **COMFORT** is a decreased airflow used to improve humidity control. **EFFICIENCY** is the airflow used to meet specified ratings. **MAXIMUM** is a fixed airflow speed of 400 CFM/ton based on the outdoor unit size.

### DEHUM AIRFLOW:

- NORMAL (default)
- HIGH

Normal airflow adjustment used during dehumidifying. If duct sweating is an issue, selecting **HIGH** will increase the dehumidifying airflow speed and reduce the sweating.

### HEATER SIZE:

- (choices dependent upon fan coil model)

This will show the heater size entered during the start-up process. This value can be changed to another value (limited by the model of the fan coil). If the electric heater is self-identifying, this value is not shown.

## **SETUP = HEAT PUMP / AC:**

### COOLING LOCKOUT:

- NONE (default)
- 45° F.
- 50° F.
- 55° F.

Outside temperature below which cooling will not be provided.

### ENTERED SIZE:

- (dependent on indoor unit model)

Size of the outdoor unit entered during the start-up process. If the outdoor unit is a communicating model, this value will not be shown. This size can be changed here but is limited to sizes that the indoor unit can handle.

### DEFROST INTERVAL:

- 30 minutes
- 60 minutes
- 90 minutes (default)
- 120 minutes

Time interval at which defrost cycles can occur on a heat pump.

### ELECT HEAT LOCKOUT:

- NONE (default)
- +5 to 55 deg. F

Outside temperature above which the electric heat will not operate.

### HIGH COOL LATCH:

- NONE (default)
- 80 - 110 deg F

Outside temperature above which only the high speed (of a 2-speed outdoor unit) will run when cooling.

## **SETUP = ACCESSORIES**

### FILTER TYPE:

- MEDIA
- EAC
- MEDIA+EAC

CLEAN INTERVAL: 30 to 180 days (of blower operation). (Default = 90)

Interval at which the Clean Filter notification will turn on. Applies to EAC or MEDIA+EAC filter selection only.

## **SETUP = HUMIDIFIER**

### HUMIDIFIER INSTALLED:

- NO
- YES

If YES, indicates to the system whether a humidifier is installed and enables humidification functions.

CHANGE PAD INTERVAL: 1 to 24 months of humidifier operation (default=6 months)

Interval at which the Change Humidify Pad notification will be displayed.

### HUMIDIFY WITH FAN:

- NO (default)
- YES

If YES, the humidifier will run with Continuous Fan if there is a humidify demand.

## **SETUP = VENTILATOR**

**NOTE:** Only appears if ventilator is installed.

### CLEAN INTERVAL:

- 60 to 180 days of operation (default=90)

Interval at which the Clean Ventilator Pre-filter notification will turn on.

## **SETUP = UV LIGHTS**

### UV LIGHTS INSTALLED:

- NO
- YES

If YES, indicates to the system whether UV lights are installed.

### CHANGE INTERVAL:

- 6 to 48 months operation time (default=12 months)

Interval at which the Change UV Lights notification will be displayed.

## **SETUP = SYSTEM MAINTENANCE**

### REMIND OWNER OF ROUTINE MAINTENANCE EVERY:

This setup is used to adjust the timer interval in which the normal System Maintenance notification is turned on for the homeowner.

- Range= OFF, 6 to 24 months, (default=12)

## CHECKOUT MENUS

The Checkout menu will show the equipment installed in the system. A sample checkout menu is shown in Fig. 24.

CHECKOUT	
FURNACE HEAT PUMP HEATING HEAT PUMP COOLING HUMIDIFIER VENTILATOR	
< BACK	SELECT >

A03204

Fig. 24 — CHECKOUT MENUS

### Checkout = FURNACE

Make sure the furnace is properly installed before continuing.

- LOW HEAT RUNTIME: 5 min.
- HIGH HEAT RUNTIME: 5 min.

This menu item allows the furnace to be exercised. First, a low heat runtime and high heat runtime are selected.

If only the low heat is to be exercised:

The furnace will execute its ignition start-up sequence. This sequence will be displayed on the Infinity Control screen. After the gas valve and blower motor turn on, the screen will automatically change to show the current operating status of the furnace.

### Checkout = FAN COIL

#### ELECTRIC HEAT CHECK

- ELECTRIC HEAT RUNTIME: 5 min., Default time = 5 min., Range = 0 - 120 min.

If you have a fan coil with electric heaters, this menu item will allow the heaters to be exercised.

With self-identifying electric heaters, three stages of electric heat are available to be exercised in any combination. Non-identifying heaters will only provide one stage of heat.

Enter the run time (in minutes) of each stage of heat to be exercised then press START (right-side button). The display will change to show the fan coil's operating status.

### Checkout = HEAT PUMP HEATING

- HIGH HEAT RUNTIME: 5 min.
- LOW HEAT RUNTIME: 5 min.
- DEFROST: NO

The heat pump heating mode can be exercised with this menu option. With a 2-speed heat pump, a low heat runtime and a high heat runtime are independently selectable to exercise. A defrost cycle is also selectable. Default time = Fixed 5 min. minimum, range = 5 - 120 min.

### Checkout = HEAT PUMP COOLING OR AC COOLING

- HIGH COOL RUNTIME: 5 min.
- LOW COOL RUNTIME: 5 min.

The heat pump cooling mode (or AC cooling mode) can be exercised with this menu option. With a 2-speed heat pump or AC unit, a low cool runtime and a high cool runtime are independently selectable to exercise. The display will change to show the heat pump or AC operating status. Default time = Fixed 5 min. minimum, range = 5 - 120 min.

### Checkout = HUMIDIFIER

- ON
- OFF

The humidifier can be exercised On and Off with this menu option.

### Checkout = VENTILATOR

The ventilator can be exercised through all of its operating speeds with this menu option.

## SERVICE MENUS

The Service Info menu will only show the equipment installed in the system. Below is a sample using a furnace and a dual fuel heat pump. A sample service menu is shown in Fig. 25.

SERVICE INFO	
FURNACE STATUS HEAT PUMP STATUS LAST 10 SYSTEM FAULTS RUN/FAULT HISTORY TODAY'S DATE MODEL/SERIAL NUMBER SERVICE PHONE NUMBER	
< BACK	SELECT >

A03205

Fig. 25 — SERVICE INFO MENUS

### Service = FURNACE STATUS

The Status screens will show all of the current operating parameters of each installed piece of equipment.

#### HEAT STAGE:

- OFF, LOW, HIGH

Displays stage of heat that the furnace is currently delivering.

#### AIRFLOW CFM:

- (furnace model dependent)

Cubic Feet per Minute of air the blower is currently delivering.

#### INDUCER RPM (90% furnaces only):

- Inducer motor RPM value.

#### BLOWER RPM:

- Blower motor RPM value.

#### STATIC PRESS:

- Inches of water. Displays static pressure that the furnace is currently experiencing.

#### LOCKOUT TIMER:

- Seconds

If a lockout timer is active, this will show the current time value. See furnace manual for details on lockout timers.

### Service = FAN COIL

#### ELECTRIC HEAT STATUS:

- OFF, LOW, MED, HIGH

Displays stages of electric heat that the fan coil is currently delivering.

#### AIRFLOW CFM:

- (fan coil model dependent)

Cubic Feet per Minute of air the blower is currently delivering.

#### BLOWER RPM:

- Blower motor RPM value

#### STATIC PRESS:

- Inches of water

Displays static pressure that the fan coil is currently experiencing.

## Service = HEAT PUMP / AC STATUS

### STAGE: (HEAT / COOL):

- OFF, LOW, HIGH

Displays stage of heating or cooling that the heat pump/AC is delivering.

### DEFROST:

- NO, YES

Displays status of defrost mode if heat pump.

### AIRFLOW CFM:

- Indoor unit cfm measurement.

### BLOWER RPM:

- RPM feedback from indoor motor.

### COIL TEMP:

- Degrees F.

Temperature of the outdoor unit coil (only available on 2-speed communicating outdoor units).

### STATIC PRESS:

- Static pressure of indoor unit.

## Service = LAST 10 SYSTEM FAULTS

This screen will show last 10 faults that occurred throughout the system. Each fault has the time and date of incident recorded. Service technician should enter current date in "TODAY'S DATE" menu section before checking and logging the last 10 system faults. Each fault has a two-letter acronym preceding the fault name to identify which piece of equipment generated the fault.

- HP = heat pump
- AC = air conditioner
- FN = furnace
- FC = fan coil.

## Service = RUN / FAULT HISTORY

The indoor unit and outdoor unit (if communicating) has the following histories:

**NOTE:** For Critical Fault Screens, see Trouble Shooting section in this document.

### Resettable Faults:

- Fault counters for each piece of equipment that can be reset.

### Cycle Counters:

- Number of heat/cool/power cycles the unit has performed.

### Run Times:

- Lifetime hours of operation in heating, cooling, and how long the unit has been powered.

## Service = TODAY'S DATE

- This menu item allows the installer to enter the current date. It is used for time/date stamping of system faults. This should be entered every time prior to viewing "LAST 10 SYSTEM FAULTS" section.

## Service = MODEL / SERIAL NUMBERS

- If available, this menu item allows the installer to view the model number and serial number of all communicating pieces of equipment in the system.

## Service = SERVICE PHONE NUMBER

This menu item allows the installer to enter a name and phone number that the homeowner can call for future service of the system. This name and phone number will appear to the homeowner whenever a service reminder pop-up message is displayed (i.e. Change Filter, etc.)

To edit:

- Use Temp +/- button to move cursor left and right.
- Use Time +/- button to select numbers and letters.
- Use Scroll button to move up and down between NAME and NUMBER.

## OPERATIONAL INFORMATION

### Continuous Fan Operation

Pressing FAN button will scroll through the following:

- AUTO = No fan operation except during equipment operation.
- LOW = Approximately 50% of High Speed operation.
- MED = The difference between High and Low speed operation.
- HIGH = Highest of either High Heating or High Cooling CFM.

### Five-Minute Compressor Timeguard

This timer prevents compressor from starting unless it has been off for at least 5 minutes. It can be defeated by simultaneously pressing the Fan and Temp + buttons.

### Emergency Heat (for heat pump applications)

To activate Emergency Heat, you **must** press and hold the HEAT button for 3 seconds to activate.

### Keypad Lockout

Keypad can be locked by pressing Fan and Humidity/OAT buttons at the same time for 3 seconds. When keys are locked, a lock symbol will appear in the upper left corner of screen. Follow same procedure to unlock keypad.

### Heat and Cool LED

The Heat and Cool LEDs will pulsate during actual equipment operation.

### Equipment Cycle Timer (adjustable 4-6 cycles per hour)

This timer prevents the start of a heating or cooling cycle until 15 (or 10) minutes after the last start of the same cycle. Its function is to assure that the equipment is not cycled more than the selected times per hour. This timer is adjustable from 4 to 6 cycles per hour. This timer is defeated for one cycle when the desired temperature is manually changed. It can also be defeated for one cycle by simultaneously pressing the Fan and Temp + buttons.

### Ten-Minute Staging Timer

In multistage heating or cooling, this timer prevents any higher stage from turning on until the preceding stage has been on for 10 minutes. This timer is defeated if temperature error is greater than 5°F (usually due to a large change in desired temperature).

### Three-Minute Minimum On Time

In normal operation, when a stage turns on, it will remain on for a minimum of three minutes. If the set point is changed, this timer is automatically cancelled, allowing the equipment to turn off immediately when the demand is removed.

### Heat/Cool Set points (Desired Temperatures)

A minimum difference of 2° (default) is enforced between heating and cooling desired temperatures. This is done by allowing one setting to "push" the other to maintain this difference. This difference is adjustable via the Install/Service menu under Thermostat Setup.

### Auto Changeover

When Auto mode is enabled (factory default) a change from heat to cool (or vice versa) will not occur until an opposite mode demand has existed for 30 minutes. If the set point is changed, the 30-minute requirement is defeated. This Auto Changeover time is adjustable via the Install/Service menu under Thermostat Setup. Range = 5 - 120 min.

### Smart Recovery

With Smart Recovery selected (factory default), transition out of setback begins a fixed time period before selected recovery time and gradually adjusts room temperature so desired temperature will be achieved at selected recovery time. The fixed time period is 1.5 hours. It operates in both heating and cooling. This only applies to programmable operation.

#### Media Filter

If a **media** filter is installed in the indoor unit, the system will perform a static pressure check of the system whenever power is applied to the system, or the system is transitioned from Off to Cool or Heat modes. The blower will run at a medium airflow for one minute.

#### TrueSense™ Dirty Filter Detection

When MEDIA or MEDIA+EAC is installed, a static pressure check will automatically be performed every 24 hours at 1:00PM to monitor filter accumulation.

### TROUBLESHOOTING

#### Infinity Control™ does not power up.

1. Recheck wiring to ABCD on all devices.
2. Make sure all colors match for every terminal.
3. Make sure power is applied to the indoor unit, and the amber LED is lit on indoor control circuit board.
4. Check for 24VAC between the C and D terminals at Infinity Control™ terminal connector.
5. Check fuse on indoor unit's circuit board.

#### Display says "Indoor Unit Not Found"

1. Recheck wiring to ABCD on all devices.
2. Make sure all colors match for every terminal.
3. Press left-side button to try again.
4. If display still reads "Indoor Unit Not Found", disconnect **all** devices from ABCD and connect User Interface directly to indoor unit.

#### Display says "Outdoor Unit Not Found", and I have a two-speed communicating outdoor unit:

1. Recheck wiring to ABCD connector on outdoor unit.
2. Make sure all colors match for every terminal.
3. Check for 24VAC between the C and D terminal connector.

#### I made a mistake on the start-up screens, and hit the right-side button to get to the run mode. How do I get back to start-up?

1. Press the ADVANCED button for at least 10 seconds.
2. Install/Service menu will appear.
3. Scroll down to the INSTALL selection.
4. Press the right-side button; the screen will prompt you to press the right side again to re-install the system.

#### CRITICAL ALERT SCREEN

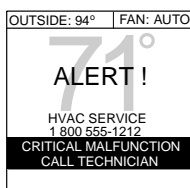

Fig. 26 — Critical Alert Screen

A04027

The following errors will cause a Critical Malfunction screen to pop up. Heat and Cool LEDs will alternately flash at a 1 second rate.

#### FAN COIL

Code 44 - Motor Communication Fault

Code 41 - Blower Motor Fault

#### FURNACE

Code 15 - Blower Motor Lockout

Code 22 - Abnormal Flame Proving Signal (not dual fuel)

Code 41 - Blower Motor Fault

#### USER INTERFACE

No communication with indoor unit

#### SYSTEM MALFUNCTION SCREEN

The following errors will cause a System Malfunction Screen to pop up:

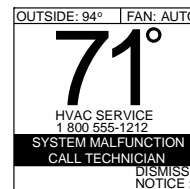

Fig. 27 — System Malfunction Screen

A04028

#### FAN COIL

Code 37 - Heater output sensed ON when not energized

#### FURNACE

Code 13 - Limit Circuit Lockout

Code 14 - Ignition Lockout

Code 21 - Gas Heating Lockout

Code 22 - Abnormal Flame Proving Signal (dual fuel only)

Code 23 - Pressure Switch Did Not Open

Code 24 - Secondary Voltage Fuse Open

Code 33 - Limit Circuit Fault AND High Heat Only is active

Code 45 - Control Circuitry Lockout

**NOTE:** For all the above furnace error codes, the system will use heat pump heating exclusively if available. When the error code is cleared or disappears, furnace heating will resume.

#### TWO-SPEED OUTDOOR UNIT

Code 85 - VC voltage at standby

Code 86 - High capacity compressor lockout

#### USER INTERFACE

Temp Sensor Failed, "NO SENSOR DATA" shown in place of actual temp.

Outdoor Unit communication fault.

Network Interface Module (NIM) communication fault

Defrost Error (defrost signal on for more than 15 minutes)

The user can press the right side button to dismiss the notice. The regular run mode screen will then appear except "SYSTEM MALFUNCTION" will appear in place of the day/time. If the error has not disappeared within 24 hours, the above display will return. If the error code disappears, "SYSTEM MALFUNCTION" will disappear and the day/time will reappear.